



QLogic Solutions Lab

Reference Architecture for Server Virtualization

2600, 3400, and 8400 Series Adapters

Information furnished in this manual is believed to be accurate and reliable. However, QLogic Corporation assumes no responsibility for its use, nor for any infringements of patents or other rights of third parties which may result from its use. QLogic Corporation reserves the right to change product specifications at any time without notice. Applications described in this document for any of these products are for illustrative purposes only. QLogic Corporation makes no representation nor warranty that such applications are suitable for the specified use without further testing or modification. QLogic Corporation assumes no responsibility for any errors that may appear in this document.

Document Revision History	
Revision A, November 24, 2014	
Changes	Sections Affected
Initial release of new document.	

Table of Contents

1	Introduction	
	Intended Audience	1
	What Is in This Guide	1
	Virtualized Environments Overview	2
2	Network Connectivity	
	QLogic 3400 Series Ethernet NIC	3
	QLogic 8400 Series Converged Network Adapter	4
	Network Connectivity Recommendations.	5
3	Traffic Isolation Using VLANs	
4	Storage Connectivity	
	QLogic 2600 Series Fibre Channel Adapter.	9
	QLogic 8400 Series Converged Network Adapter	9
	Storage Connectivity Recommendations	10
	Fibre Channel Storage	10
	iSCSI and FCoE Storage.	10

List of Figures

Figure		Page
1-1	Vendor Elements of Virtualization Infrastructure and QLogic Product Positioning. .	2
3-1	Traffic Isolation.	6
4-1	High-Availability SAN	8

List of Tables

Table		Page
2-1	Impact of Hardware Offload on Application and Virtualization Performance	4

1 Introduction

Designing a high-availability and high-performance virtualized architecture means choosing best-of-breed elements that work together to deliver optimal results. The I/O infrastructure provides the connective tissue between these elements. This document describes how the versatile QLogic® Fibre Channel and Converged Network Adapters can handle any protocol, host, storage, and fabric to address the demands of the rapidly evolving, virtualized enterprise.

Intended Audience

This guide is intended for IT professionals, technical architects, sales engineers, and consultants to assist in planning, designing, and implementing virtualized data center infrastructures.

What Is in This Guide

This guide provides information in the following chapters:

- [Chapter 1 Introduction](#) provides an overview of reference architectures.
- [Chapter 2 Network Connectivity](#) describes the networking connectivity options and features of the QLogic 3400 and 8400 Series Adapters, and provides recommendations for network connectivity.
- [Chapter 3 Traffic Isolation Using VLANs](#) describes how QLogic 3400 and 8400 Series Adapters separate LAN traffic by using virtual LANs (VLANs).
- [Chapter 4 Storage Connectivity](#) describes high-availability storage connectivity requirements, lists features of the QLogic 2600 and 8400 Series Adapters, and provides QLogic recommendations for storage connectivity.

Virtualized Environments Overview

Multiple reference architectures are used for building a virtualized environment. Many vendors have one specific to their products for either the compute (server manufacturers) or the storage (SAN manufacturers). Major whole-system OEMs have complete environments based on their compute and storage products. All virtualized reference architectures include four main elements:

- Compute
- Network
- Storage
- Hypervisor

All reference architectures have these elements. However, the I/O hardware—which is responsible for the connectivity between the compute and storage, as well as between the compute and network elements—is often overlooked. This document provides an overview of the QLogic products that act as the “nervous system”: I/O connectivity products that can be applied to almost all existing reference architectures, as shown in [Figure 1-1](#).

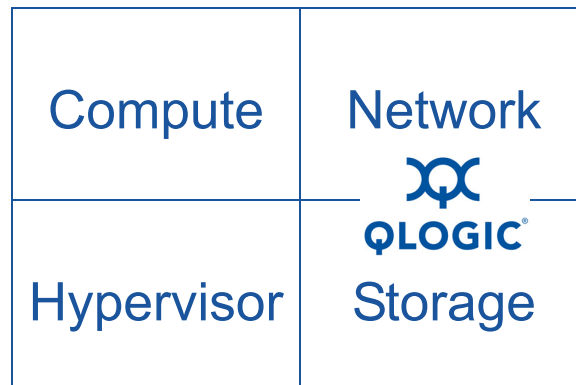

Figure 1-1. Vendor Elements of Virtualization Infrastructure and QLogic Product Positioning

2 Network Connectivity

Modern virtualized infrastructures can place a tremendous emphasis on the quality of the employed network. In current virtualization architectures, 10GbE is the preferred medium to allow for the level of virtual machine (VM) scalability that today's servers can host. Two main options for 10GbE hardware are standard 10GbE NICs and 10GbE Converged Network Adapters. QLogic has products in both these classes.

When choosing between a standard NIC or Converged Network Adapter, the storage used may be a deciding factor. NICs provide only Ethernet traffic for the VMs and software-based iSCSI for storage. Converged Network Adapters are designed to support hardware-offloaded iSCSI and Fibre Channel over Ethernet (FCoE) storage architectures, in addition to providing standard Ethernet traffic for the VMs.

QLogic 3400 Series Ethernet NIC

The QLogic 3400 Series Intelligent Ethernet Adapters feature industry-leading 10Gbps line-rate performance for exceptional vMotion® results. These low-profile PCI Express® form factor adapters come in single- and dual-port models, with connectivity options including 10GBASE-T (RJ45), short range (SR), and direct-attach copper (DAC).









The 3400 Series Adapters support tunneling offloads for Virtual Extensible LAN (VXLAN) and Network Virtualization using Generic Routing Encapsulation (NVGRE), teaming, jumbo frame, and stateless offload features. Quality of service (QoS) is ensured with the ability to define multiple virtual adapters per physical port using QLogic's switch-independent NIC partitioning (NPAR).

Concurrent support for switch-independent NPAR and single-root I/O virtualization (SR-IOV) enables virtual environments with the choice and flexibility to create an agile virtual server platform. The QLogic 3400 Series also offers pre-execution environment (PXE) and unified extensible firmware interface (UEFI).

QLogic 8400 Series Converged Network Adapter

The QLogic 8400 Series Converged Network Adapters offer 10Gbps per-port maximum throughput for high-bandwidth storage and networking traffic. Ultra-low server CPU usage is achieved through full hardware offload of FCoE and iSCSI protocols, as shown in [Table 2-1](#).

Table 2-1. Impact of Hardware Offload on Application and Virtualization Performance

Network Adapter	Built-In Hardware Offload	I/O Burden on Server CPU	Application and Virtualization Performance
 Traditional NIC	No		
 Software-based Converged Network Adapter	No		
 8400 Series Converged Network Adapter	Yes		

With industry-leading FCoE (2.6 million IOPS) and iSCSI (1.5 million IOPS) performance, latency is greatly reduced in high-transaction intensive applications and virtualized environments. These low-profile PCI Express form-factor adapters come in single- and dual-port models with support for SFP+ direct-attach copper cables and SR optical transceivers.

The 8400 Series Converged Network Adapters support today’s most compelling set of powerful networking virtualization features: SR-IOV, NPAR, tunneling offloads (VXLAN and NVGRE), and industry-leading performance, thus enhancing the underlying server virtualization features. The 8400 Series Adapters reduce hardware, cabling, and management costs by enabling more applications (VMs) to run on a single server.

Network Connectivity Recommendations

For maximum flexibility, QLogic recommends using the 8400 Series Converged Network Adapter for network connectivity because this single card provides Ethernet, hardware iSCSI, and FCoE with full hardware offload. These features reduce the server CPU burden and improve application and virtualization performance. A typical environment should have at least two adapters per server for redundancy and scaling purposes, in addition to the existing on-board Ethernet ports included with most servers.

For example, the ports are provisioned in the hypervisor as follows:

- Onboard NICs—Two to four, depending on the server. The NICs are bonded or used on a single virtual switch (vSwitch) for management of the hypervisors.
- 10GbE NICs or Converged Network Adapters—Four ports (because the adapters are dual port). The ports are bonded or used on the same vSwitch for the NIC virtual function.

3 Traffic Isolation Using VLANs

The LAN traffic is typically separated into three VLANs: one VLAN each for management, vMotion, and VM traffic. Network traffic is tagged with the respective VLAN ID for each traffic type in the vSwitch. Tagging is achieved with the Virtual Switch VLAN Tagging (VST) mode. In VST mode, a VLAN is assigned to each of the three port groups. The virtual switch port group tags all outbound frames and removes tags for all inbound frames.

The QLogic 3400 Series and 8400 Series Adapters offer the ability to separate traffic through the traditional use of VLANs, as well as through the use of NPAR. The 3400 Series allows for up to four NIC functions per physical port on the adapter. The 8400 Series allows for two NIC functions per physical port, in addition to one FCoE and one iSCSI function per port.

Trunking must be used to ensure that all the VLANs can share the same physical connection. To achieve sharing, all of the ports connected to VMware® ESX® hosts on the physical switches are configured in the trunk mode.

Because vMotion traffic is unencrypted, QLogic highly recommends that you isolate vMotion traffic. Using the VLAN configuration described previously, traffic isolation is achieved between the various traffic types, including the vMotion traffic, as shown in [Figure 3-1](#).

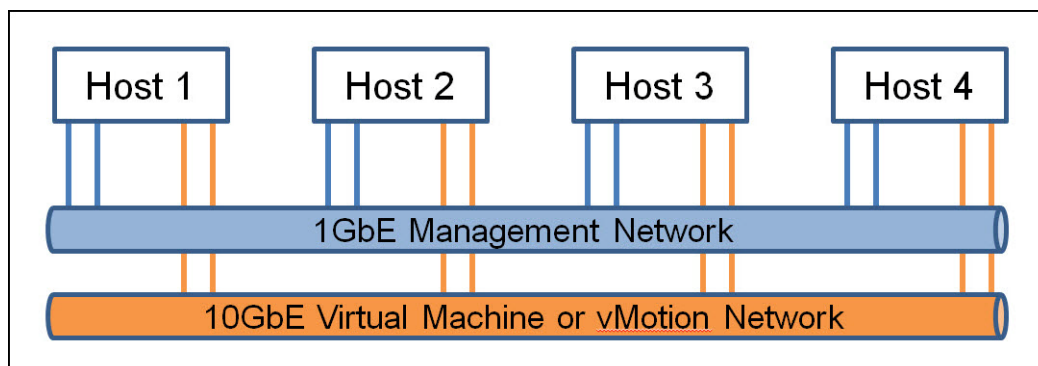

Figure 3-1. Traffic Isolation

The 8400 Series Adapter handles the traffic separation of the FCoE or iSCSI traffic internal in the adapter using virtual functions. These virtual functions are presented to the hypervisor as separate hardware appearing as storage adapters rather than as network adapters. Virtual functions allow the use of hardware-offloaded FCoE and iSCSI while still servicing standard Ethernet traffic. QoS can be set in the adapter to provide consistent performance of the storage protocols.

4 Storage Connectivity

When designing an architecture for a highly available virtualized environment, the storage must be shared using a SAN. SANs have several connectivity options, but are generally Fibre Channel, FCoE, or iSCSI. FCoE and iSCSI are Ethernet-based networks that use the same infrastructure described in [3 Traffic Isolation Using VLANs](#).

SANs require a separate switching infrastructure called the *fabric*. The storage fabric must include both an A and B fabric, requiring a minimum of two separate switches for handling the storage traffic, as shown in [Figure 4-1](#).

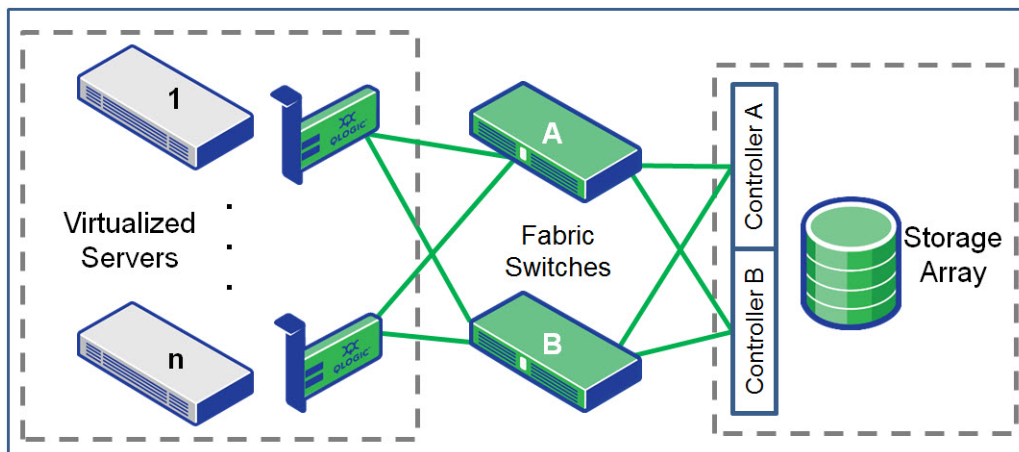

Figure 4-1. High-Availability SAN

Just like the network, QLogic recommends that you install at least two Host Bus Adapters in each server to provide both redundancy and performance. To allow for maximum redundancy, attach a single port from each card to each storage fabric. For example, attach Port 0 of each adapter to Fabric A, and attach Port 1 of each adapter to Fabric B. This architecture ensures that the environment maintains storage connectivity in the following scenarios:

- Loss of a single fabric
- Loss of a single Host Bus Adapter

- Loss of a single port on a Host Bus Adapter
- Loss of a storage controller

QLogic delivers products for the storage fabric that fall into two main categories:

- Host Bus Adapters for Fibre Channel, as described in [QLogic 2600 Series Fibre Channel Adapter](#).
- Converged Network Adapters for FCoE and iSCSI, as described in [QLogic 8400 Series Converged Network Adapter](#).

QLogic 2600 Series Fibre Channel Adapter

The QLogic 2600 Series 16Gb Gen5 Fibre Channel Adapters boast:

- Industry-leading native Fibre Channel
- Performance-achieving, dual-port line rate 16Gb Fibre Channel throughput
- Extremely low CPU usage
- Full hardware offloads
- Extensive integration into the Brocade fabric with features such as:
 - ClearLink™ Diagnostics
 - Fabric-assigned WWN (FAWWN)
 - Fabric-based Boot LUN Discovery (F-BLD)
 - Standards-based class-specific control (CS_CTL) QoS

With over 1.2 million IOPS, latency is minimized for transaction-intensive applications and virtualized environments. The 2600 Series features a true port-isolation architecture for high availability, and 100 percent predictable, deterministic, and scalable performance. QLogic StarPower™ technology offers dynamic and adaptive power management features to optimize power and bandwidth for lower power consumption and decreased cooling costs.

QLogic 8400 Series Converged Network Adapter

Network convergence using 10GbE provides opportunities for IT architects to simplify the network infrastructure while enhancing performance. The QLogic 8400 Series of Converged Network Adapters offer 10Gbps per-port maximum throughput for high-bandwidth storage and networking traffic. Ultra-low server CPU usage is achieved with full hardware offloads of FCoE and iSCSI protocols.

In addition, support for powerful virtualization features makes this adapter ideal for virtualized environments that need excellent I/O performance to service growing quantities of VMs. The ability to simultaneously support multiple protocols on the same hardware offers multitenancy flexibility and virtualized architectures.

Storage Connectivity Recommendations

QLogic recommends different adapters for Fibre Channel storage and iSCSI or FCoE storage.

Fibre Channel Storage

QLogic recommends the 2600 Series as the main work horse in Fibre Channel environments. This Host Bus Adapter is designed to handle both high throughput and high I/O workloads to meet current Fibre Channel virtual environments.

iSCSI and FCoE Storage

QLogic recommends the 8400 Series for 10GbE converged network environments. The 8400 Series Adapters offer a flexible, virtualization-optimized solution that is qualified with major server, storage, and hypervisor vendors. These adapters also offer a seamless path to high-performance, I/O virtualization for enterprise, public, and private cloud deployments.



Corporate Headquarters QLogic Corporation 26650 Aliso Viejo Parkway Aliso Viejo, CA 92656 949.389.6000 www.qlogic.com
International Offices UK | Ireland | Germany | France | India | Japan | China | Hong Kong | Singapore | Taiwan

© 2014 QLogic Corporation. Specifications are subject to change without notice. All rights reserved worldwide. QLogic, the QLogic logo, and StarPower are trademarks or registered trademarks of QLogic Corporation. ClearLink is a trademark of Brocade Communications Systems, Inc. PCI Express is a registered trademark of PCI-SIG Corporation. VMware, ESX, and vMotion are registered trademarks of VMware, Inc. All other brand and product names are trademarks or registered trademarks of their respective owners. Information supplied by QLogic Corporation is believed to be accurate and reliable. QLogic Corporation assumes no responsibility for any errors in this brochure. QLogic Corporation reserves the right, without notice, to make changes in product design or specifications.

